

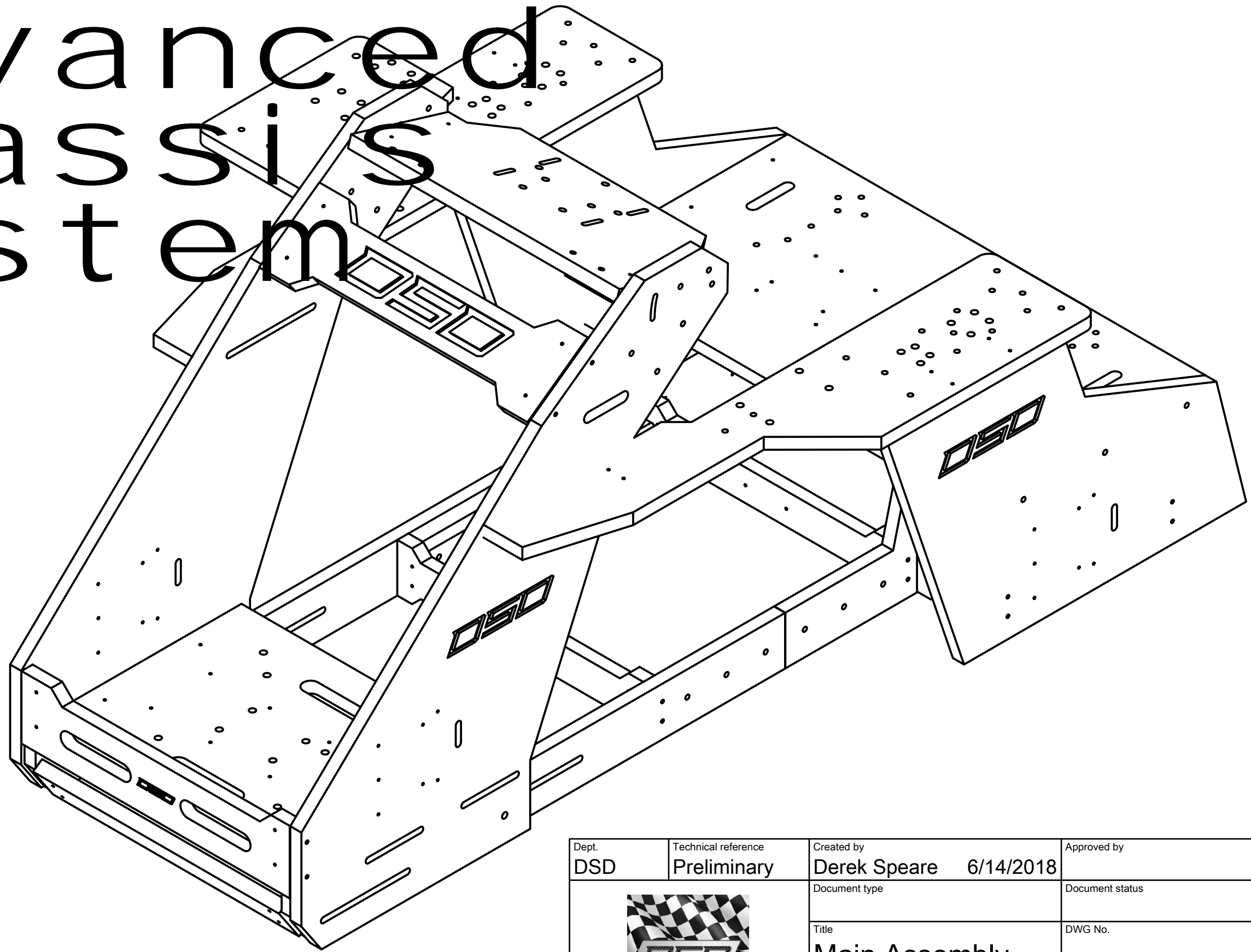



# DSD Advanced Chassis System



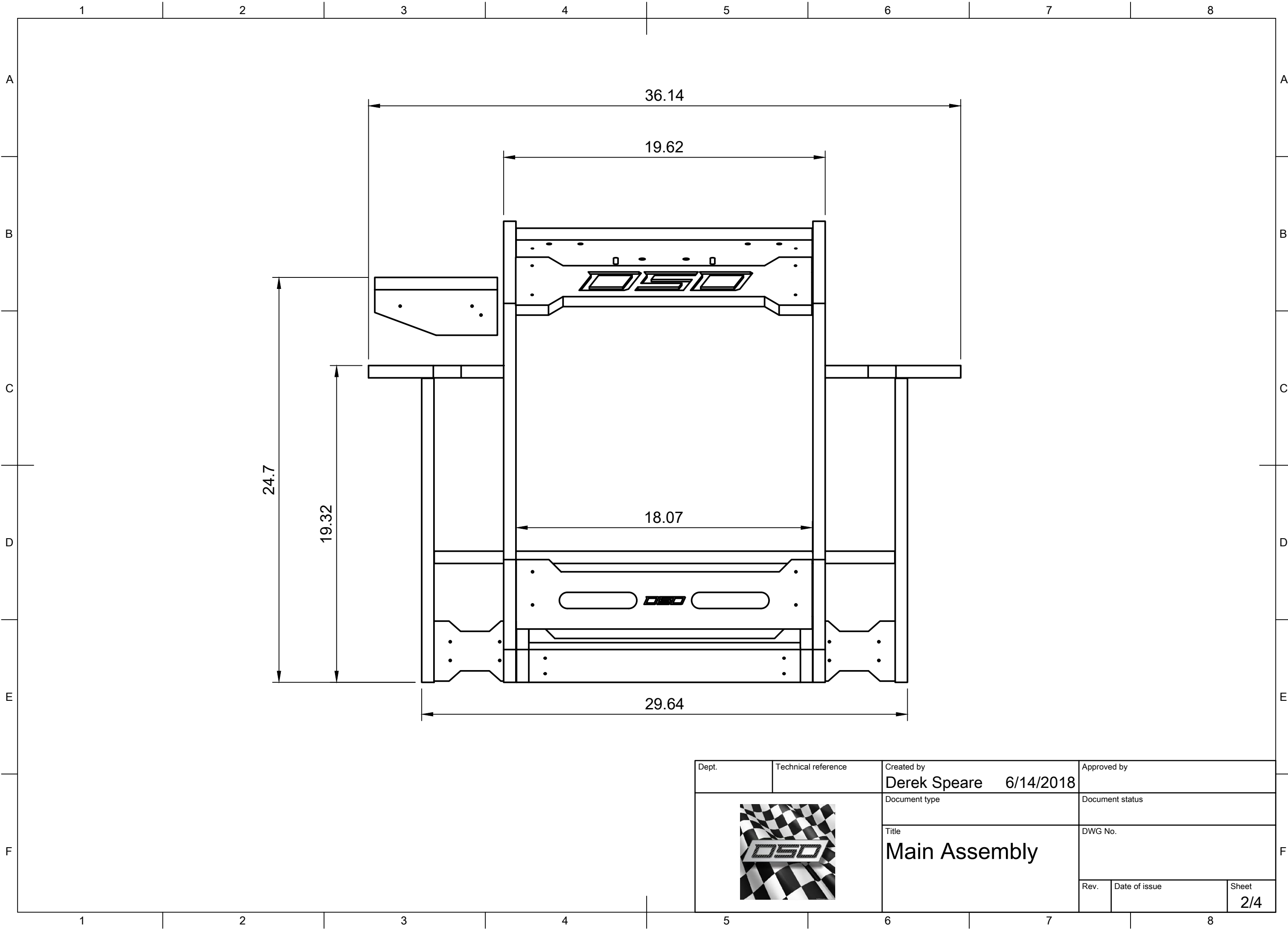

All dimensions are in inches

Dept. DSD	Technical reference Preliminary	Created by Derek Speare 6/14/2018	Approved by
		Document type	Document status
		Title Main Assembly	DWG No.
		Rev.	Date of issue
		Sheet 1/4	

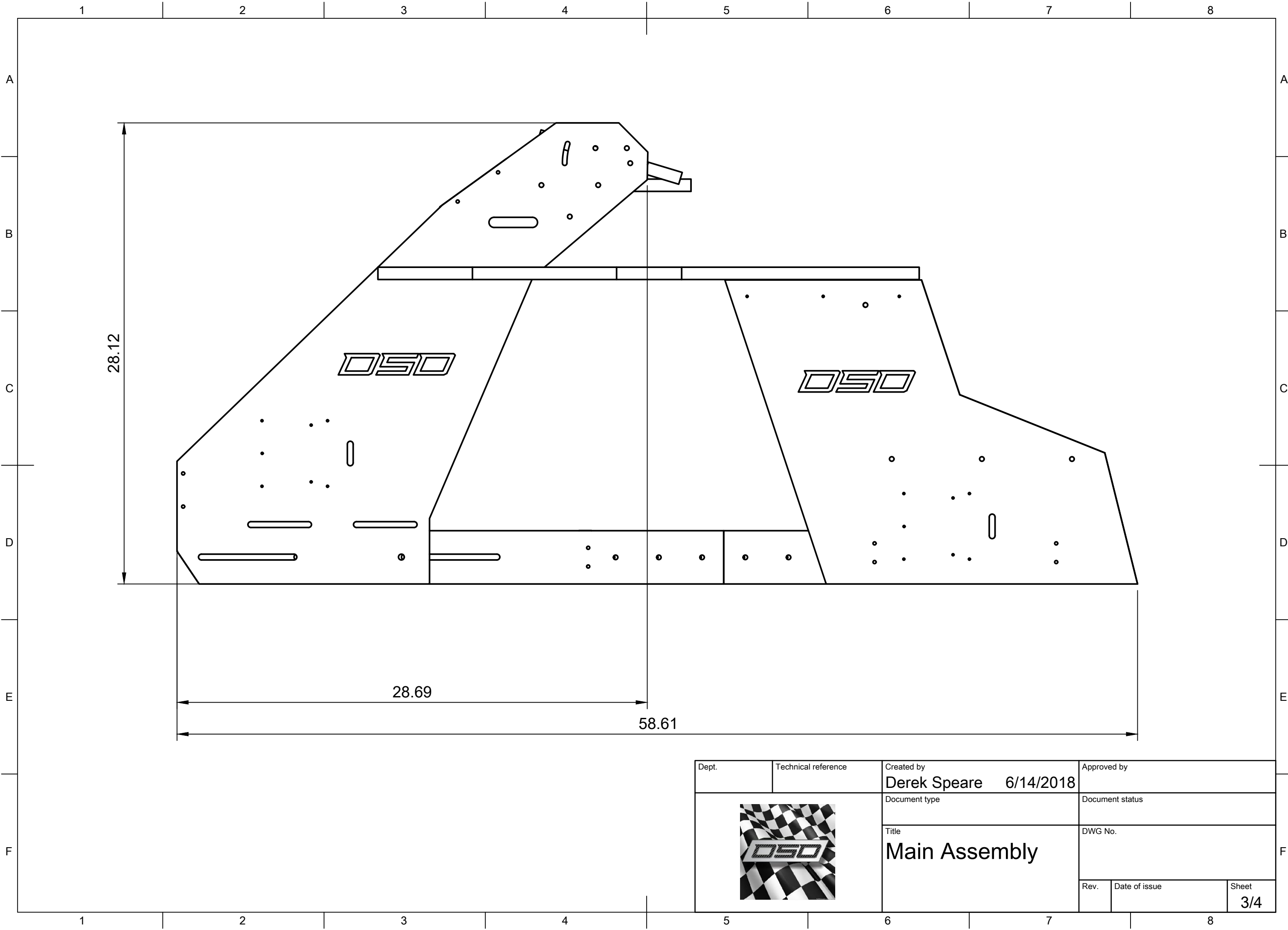

Dept.	Technical reference	Created by <b>Derek Speare 6/14/2018</b>	Approved by
	Document type	Document status	
	Title <b>Main Assembly</b>	DWG No.	
Rev.	Date of issue	Sheet <b>2/4</b>	



Dept.	Technical reference	Created by <b>Derek Speare 6/14/2018</b>	Approved by
	Document type	Document status	
	Title <b>Main Assembly</b>	DWG No.	
Rev.	Date of issue	Sheet <b>3/4</b>	

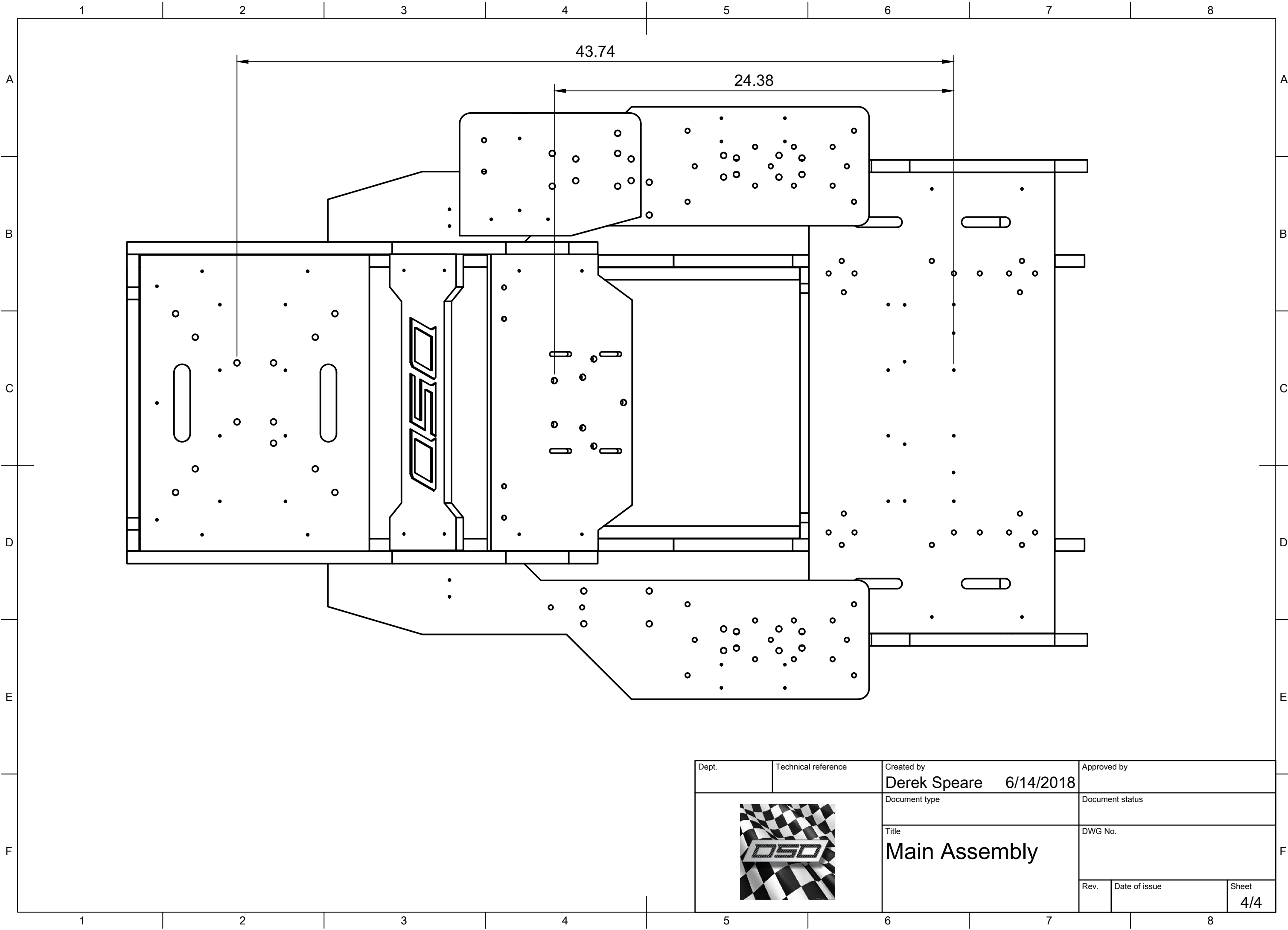

Dept.	Technical reference	Created by <b>Derek Speare 6/14/2018</b>	Approved by
	Document type	Document status	
	Title <b>Main Assembly</b>	DWG No.	
Rev.	Date of issue	Sheet <b>4/4</b>	